



ROOF STRUCTURES

Roof Structures

Types of roof structure

Traditional roofs can be divided into three main types of structure:

- Single roofs.
- Double roofs.
- Trussed roofs.

Modern construction methods make use of another type of roof structure and this is known as trussed rafter roofs (see trussed rafter roofs).

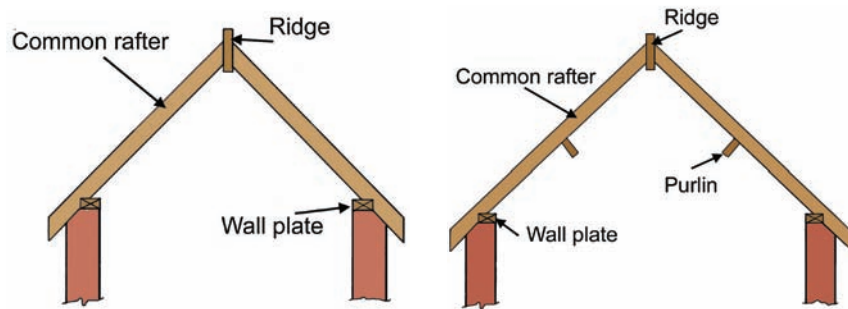

Single roof

Double roof

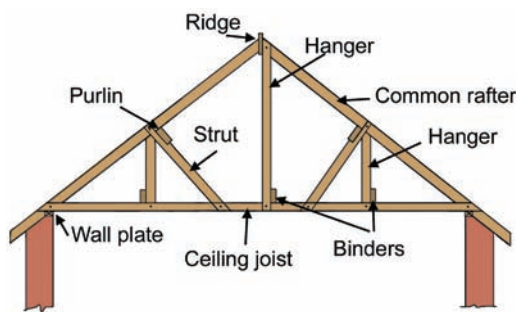

Trussed roof

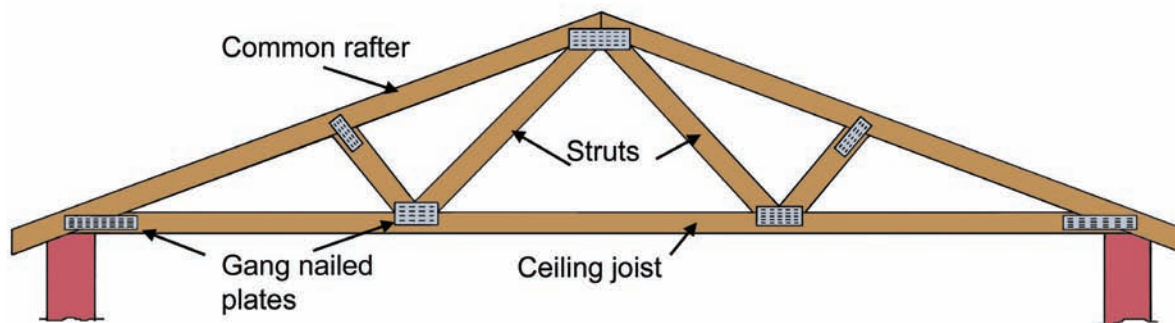

Trussed rafter roof



Single roofs

Rafters of single roofs do not require any intermediate support. This type of roof has a number of limitations. It can only be used for small spans. If greater spans are required, larger roof sections would be needed. If the feet of the rafters are not tied together by means of a binder or roof joist, then this type of roof will have a tendency, under weight, to push the supporting walls outwards at the top causing structural failure of the walls.

Single roofs can be categorised as follows:

Couple roof – These can be used for building with a clear span of not greater than 3m and pitches less than 40°.

Collar roof – These can be used for buildings with a clear span not exceeding 4mm.

Close couple roof – These can be used for buildings with a clear span not exceeding 5.5mm and with pitches less than 25°.

Couple roof

This type of roof structure is very limited in its use. The roof consists of common rafters fixed at the ridge and at the wall plate. When subjected to any type of load or force acting vertically downwards the rafters will move outwards at their feet thus exerting thrust to the walls forcing them outwards and causing possible failure of the wall structure.

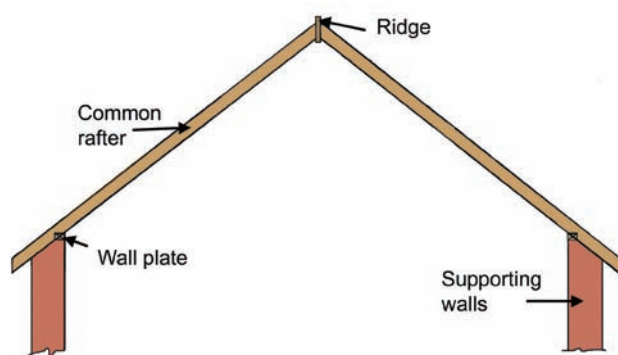

Couple roof

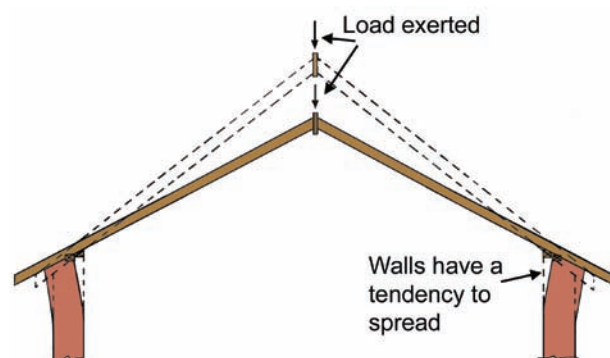

Couple roof under pressure



ROOF STRUCTURES

Collar roof

A collar roof incorporates a horizontal roof member positioned approximately one third of the distance from the ridge to the wall plate line. This extra roof member helps prevent the rafters from spreading when under load; this allows this type of roof structure to be used for greater spans than the couple roof. This design also gives a greater ceiling height if required.

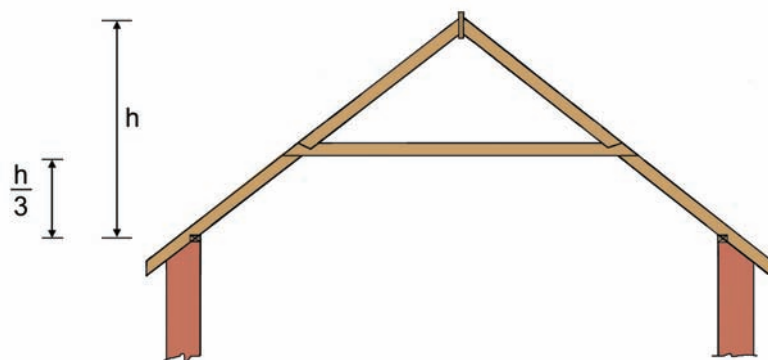

Collar roof

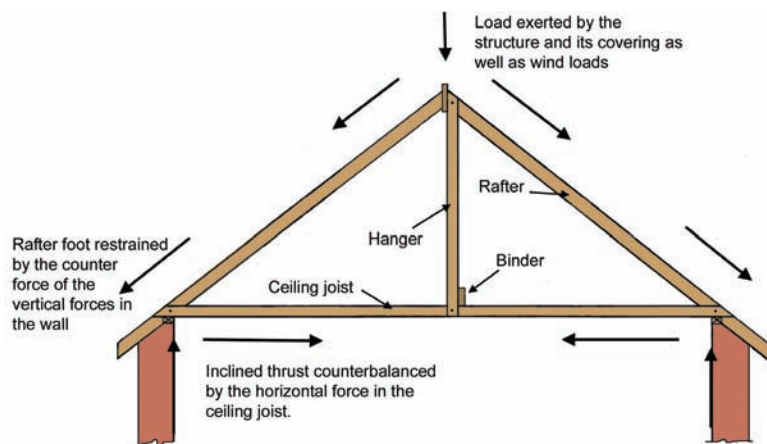

Close couple roof

Close couple roof

This roof incorporates a main tie which is secured to the feet of each rafter and spans the width of the building. This added member forms a triangle which introduces the triangulation of forces within the structure. To stop the ceiling joist from sagging, a hanger is fixed to the rafter at the top and the ceiling joist at the bottom.

To further increase the strength of this structure, a binder is fixed to each ceiling joist and hanger. This binder runs parallel with the main wall and at right angles to the ceiling joist. This type of structure ensures that this type of roof can be used for great spans without the fear of the roof spreading under loads.



Pitches, Spans and Rises

When setting out a roof, there are certain essential factors that must be considered.

These are:

Roof span – This is the distance across the roof and measured to the outer edges of the wall plates.

Roof height or rise – This is the vertical height of the roof at its highest point and is measured from the top of the wall plates to the intersection of the rafters at the top of the roof. When measuring rafters, the length is taken as a straight line running through the centre of the rafter.

Roof pitch – This is the angle or slope of the roof and can be expressed in degrees or as a fraction or ratio found by dividing the rise by the span.

Example. If a roof has a span of 6m and a rise of 3m then the pitch would be:

$$\text{Pitch} = \frac{\text{Rise}}{\text{Span}} = \frac{3}{6} = \frac{1}{2} \text{ pitch}$$

Since the rise is half the span, the angle of the roof would be 45°.

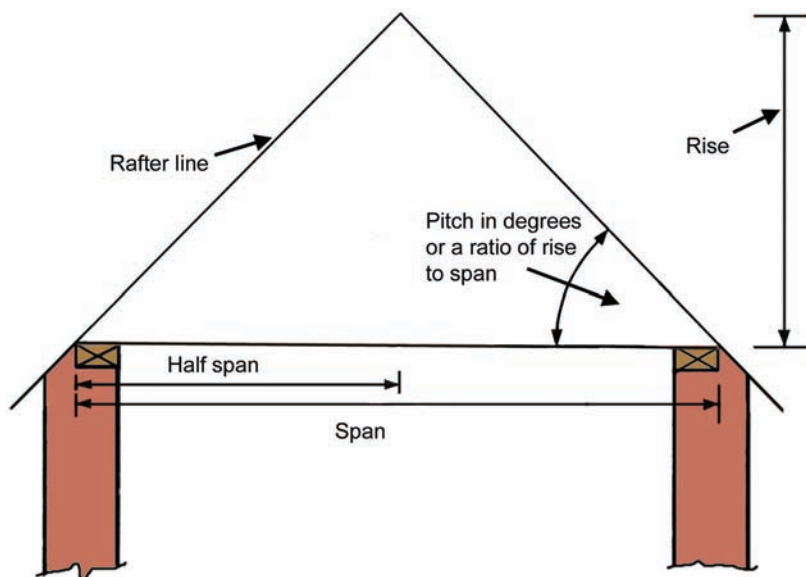

Definitions of terminology of a gable roof



ROOF STRUCTURES

Common Rafter Length and Bevels

When determining the lengths and bevels of common rafters, it is normal to consider them as single lines rather than rafters of a certain width or thickness. If the rise and the span are known, it is a simple procedure to determine the length of the common rafter and its main bevels.

The roof section can be set out full size or to scale. Once the section has been set out the length of the common rafter can be determined by drawing the rise and the span as a right angle joined together by the hypotenuse which will determine the slope of the roof.

The rafter is seated upon the wall plate by means of a notch or birdsmouth joint which is cut one third into the rafter. The angle at which the notch is cut is called the seat cut. The top angle or bevel is called the plumb cut.

Once the bevels have been determined, a sliding bevel can be set to the angle required or in some cases, a piece of plywood can be cut to each bevel and used as a template for all the other rafters.

When determining the length of the rafter, an allowance is made for the thickness of the ridge and the length of the overhang at the eaves.

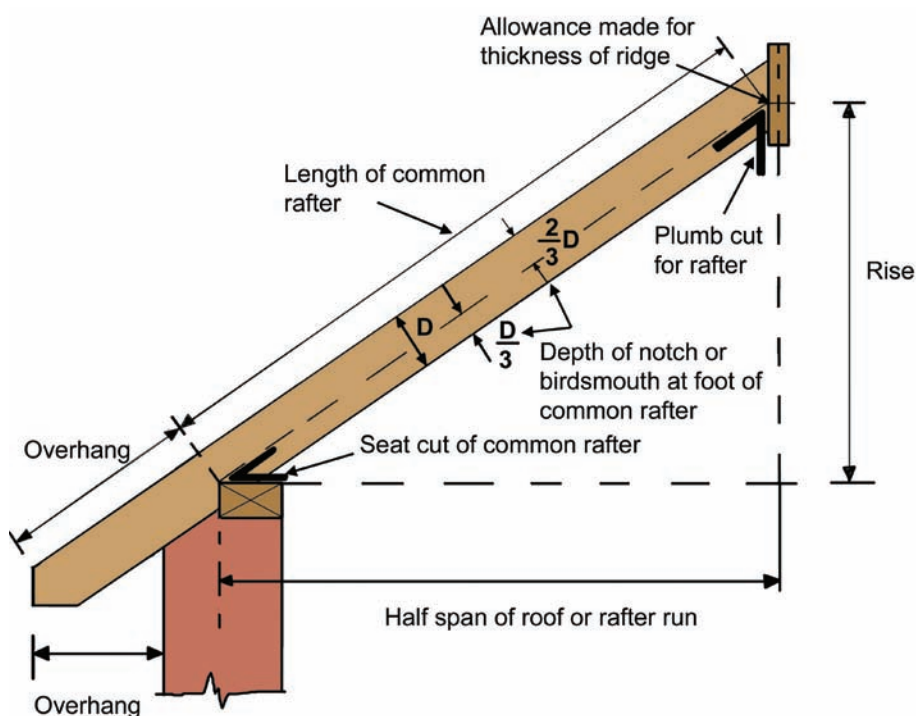

Determining the length and bevels of a common rafter



Verge Details and Ladder Frame

The construction of the verge of a gable roof is shown below. The roof extends over the gable wall to give a suitable overhang. To achieve this a simple frame called a ladder frame is constructed. This frame consists of the last two rafters joined together by means of noggings nailed to the inside of the rafters. The brickwork of the gable extends through this frame to finish the wall level with the top of the rafters.

A finishing trim called a barge board is then nailed to the last rafter. This barge board is sufficiently wider than the rafters to cover the entire end rafter including the tilting fillet.

A soffit is then fixed to the underside to match the soffit under the eaves. The barge board is also fixed to the fascia. The fascia can be mitred to the barge board at the foot while the top of the barge board at the apex of the roof is mitred to the matching barge board on the other side.

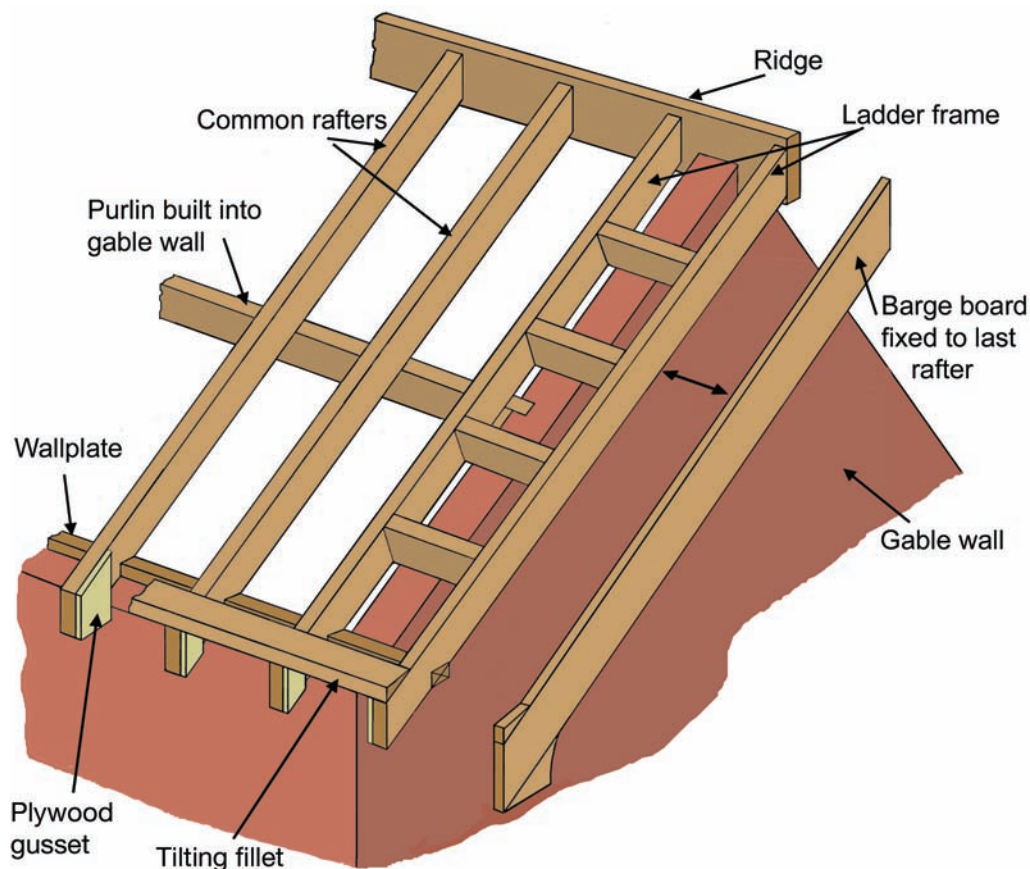



ROOF STRUCTURES

Eaves Details and Fascias

There are various ways of constructing the eaves of a gable roof. Below are two examples:

- Flush eaves.
- Boxed or closed eaves.

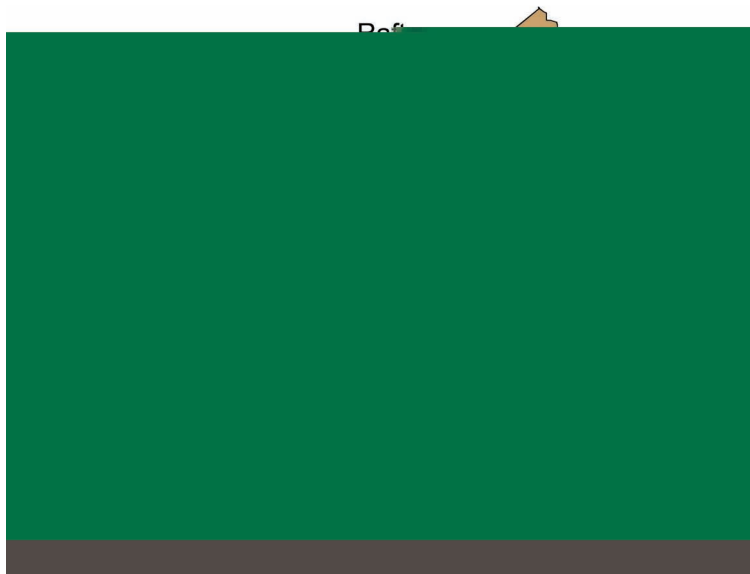

Flush eaves details

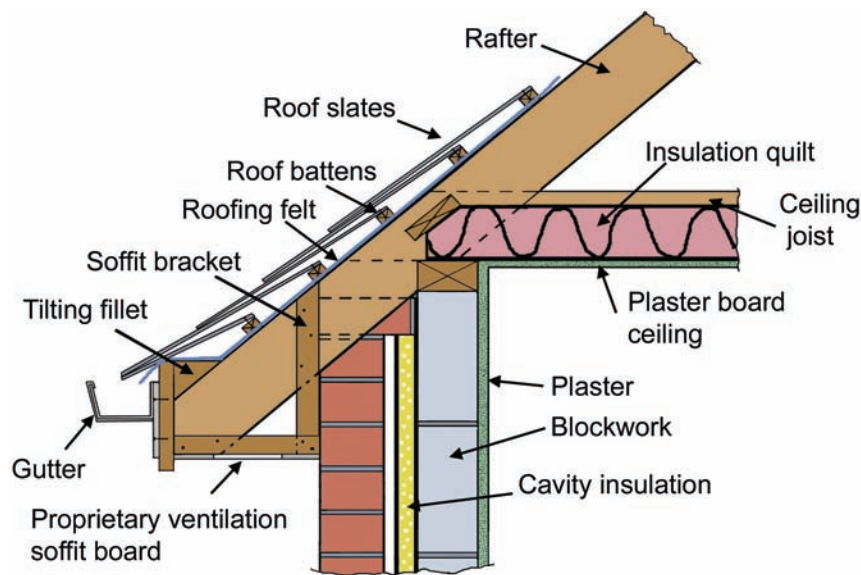

Closed or boxed eaves details



Flush eaves

In this method of finishing off the lowest edge of the roof, the rafter feet are cut plumb, and project 25mm from the face of the outer brickwork. This will allow a ventilation gap to be formed so that a continuous flow of air can circulate throughout the roof space.

The fascia board is nailed directly to the rafter feet to form a face trim. It is to this fascia board that the guttering is fixed.

Closed or boxed eaves

This is a more complex method of finishing the lowest edge of the roof. The rafter feet are allowed to overhang the face of the outer brickwork. The overhang can vary in size but usually the distance is stipulated on the working drawings, or is at a distance that can accommodate a proprietary ventilation soffit.

The soffit is supported by a cradling bracket or, in some cases, a piece of plywood cut to shape.

The roof space can be ventilated by using a proprietary vermin proof ventilation strip or the soffit can be drilled with a series of holes into which plastic ventilators are fixed.

Roof ventilation

Roof ventilation is essential to reduce the likelihood of condensation within the roof space as required by the Building Regs 1985.

The regulations state that all roofs must be cross-ventilated at eaves level by permanent vents and these must have an equivalent area equal to a continuous gap along both sides of the roof of 10mm, or 25mm where the pitch of the roof is less than 15°.

This ventilation requirement can be achieved by:

- Leaving a gap between the outer wall and the soffit.
- Using a proprietary ventilation strip.
- Using circular plastic ventilators set into the soffit board.

There are many types and designs of proprietary ventilators available all of which have been designed to give sufficient ventilation to the roof space if used and incorporated into the structure correctly.



ROOF STRUCTURES

Double Roofs

A double roof is a roof whose rafters are of such a length that they require an intermediate support. This support is usually a beam which is secured under the rafters at a point half way between the ridge and the wallplate. This beam is known as a purlin.

In gable roofs, the purlin is built into the gable wall to provide added support. In double pitched roofs, the purlin is fixed to the rafters in a continuous length, jointed at all the internal and external corners of the roof.

In traditionally constructed roofs, the roof may also require added support in the form of roof trusses. This will depend upon the size of the roof and the type of roof covering the roof has to support.

In modern double roof construction, the whole of the roof is constructed of lightweight roof trusses called trussed rafters (See Module 4).

Double roof with hipped end

There are many designs and combinations of double roofs. The design of the roof will depend upon the size and shape of the ground floor plan of the building.

The drawing shows a partly hipped roof with one hipped end and one gable end. A fully hipped roof has no gables, and the eaves run round the perimeter of the roof. The eaves are usually of the boxed or enclosed type.

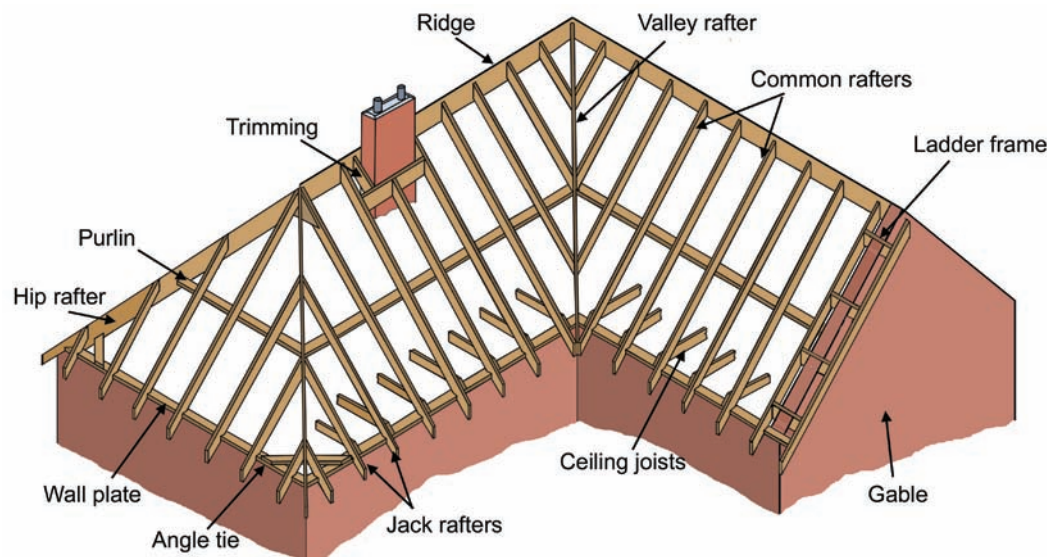

Hipped and gable roof components and terminology



Valley construction using lay board

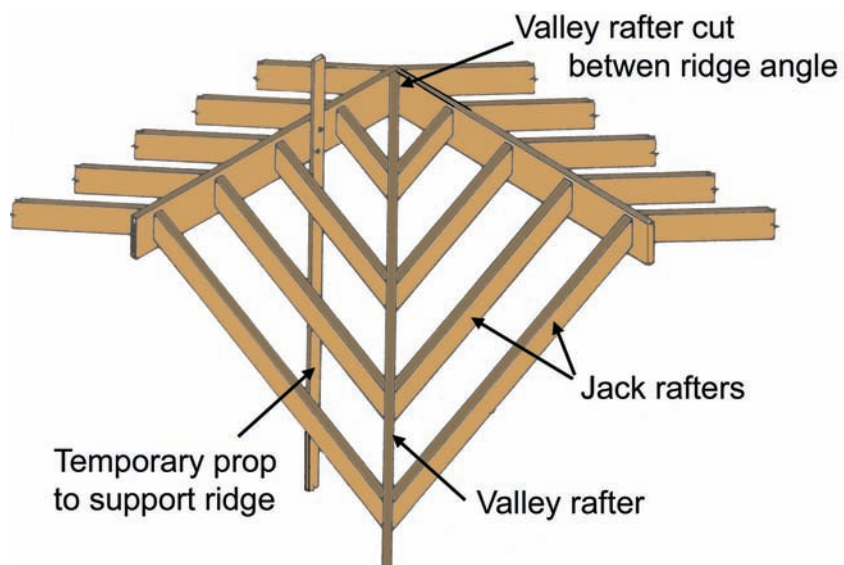
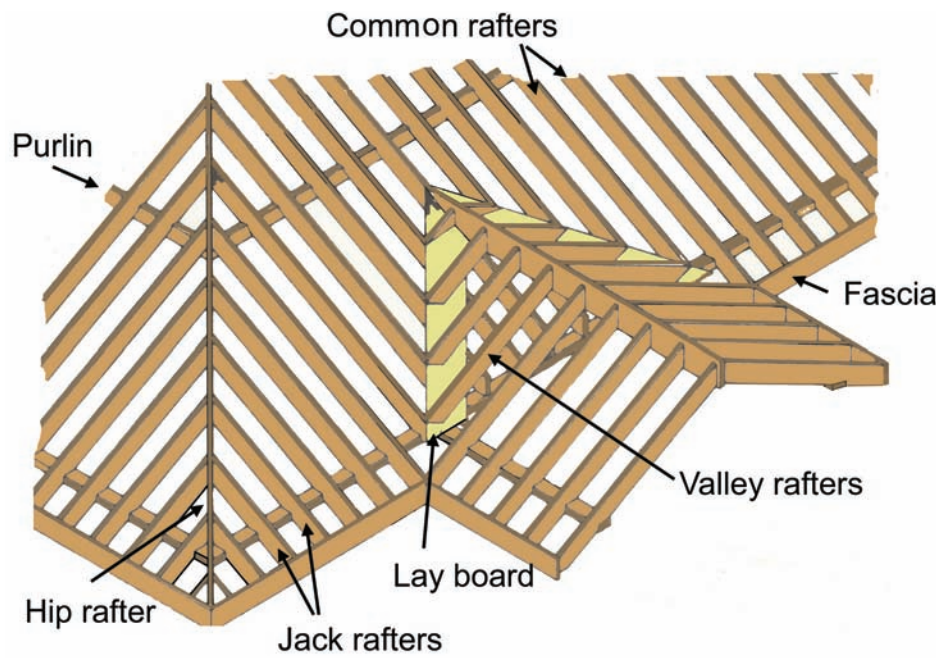

Alternate valley construction using valley rafter



Student Key Skill

Application of Number

Setting out and determining roof bevels

There are a number of ways that the length and angle of members can be determined. The roof pitch is always defined in degrees while the lengths of the members are defined in metres.

Since all roof member bevels are based on the right angle triangle principle, they can be determined by:

- The use of scaled drawings in orthographic projection.
- The use of a roofing square (simple tool based on the right angle principle and calibrated in degrees and millimetres and the length of inclined roof members).

Determining roof member lengths and bevels using orthographic projection.

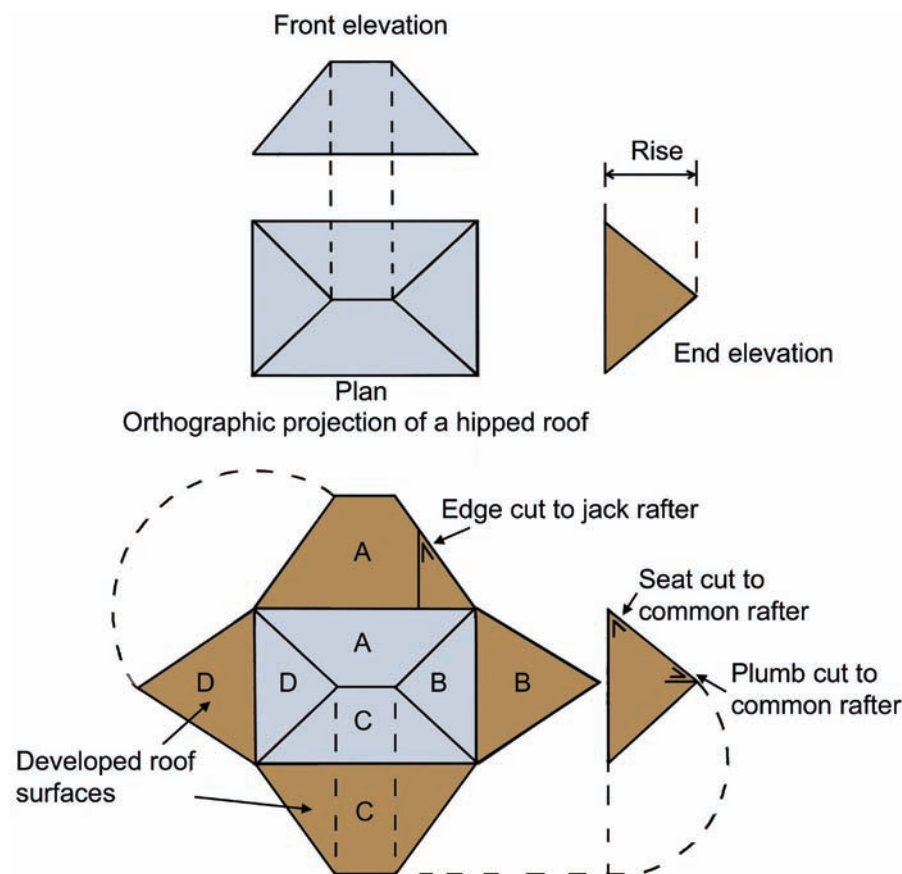

Development of sloping roof surfaces on a hipped roof



Student Key Skill

Application of Number

Determining roof member lengths and bevels using orthographic projection

Roofing angles and true lengths

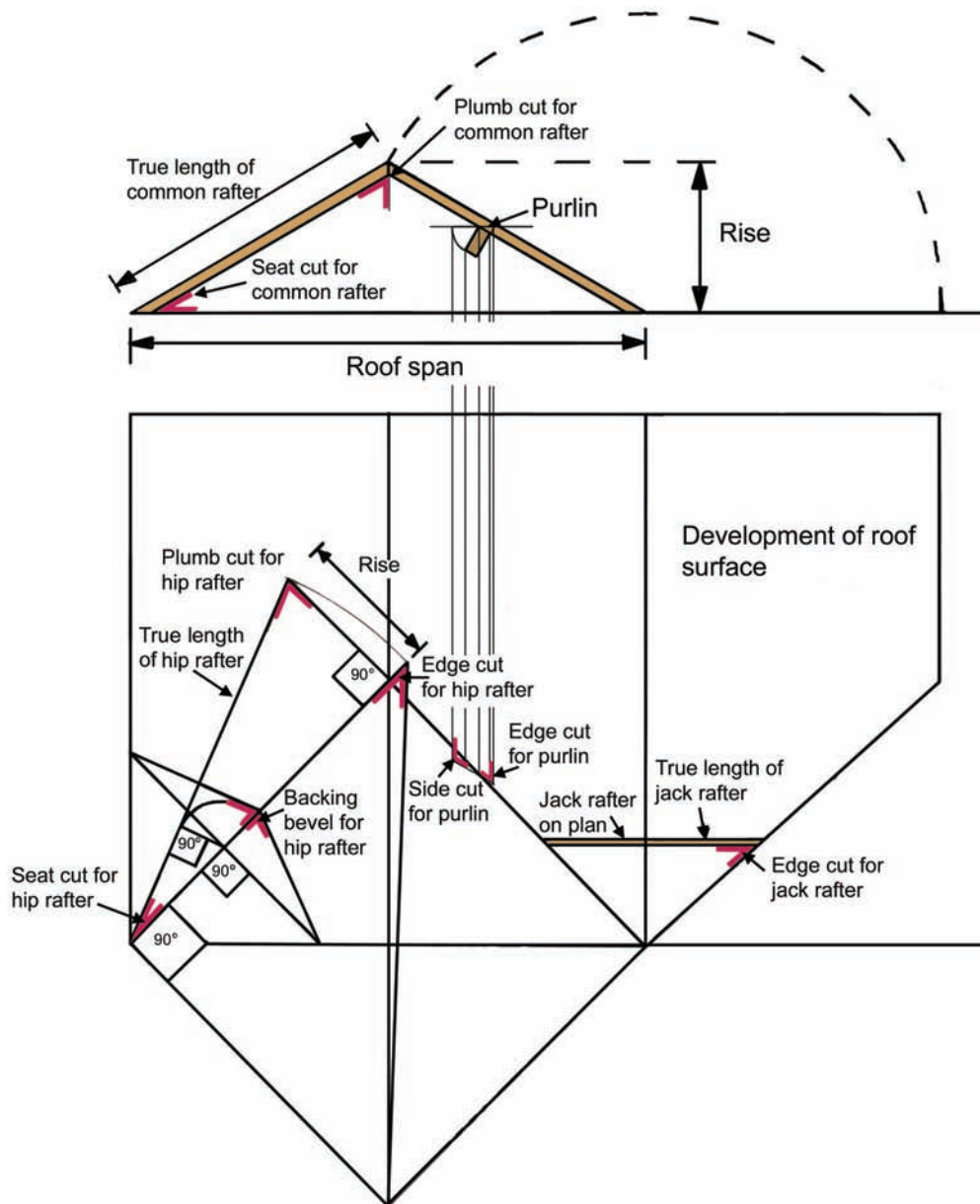

The geometry to determine the length and bevels of each individual roof member will be covered in more detail with your trainer.



Student Key Skill

Application of Number

Determining roof member lengths and bevels using a roofing square.

A roofing or framing square is a steel square which consists of two arms set at right angles to each other. One of the arms is wider and longer than the other; this is known as the blade. The shorter, thinner arm is known as the tongue.

The length of the blade is 620mm and the tongue 450mm.

The square is calibrated in millimetres and degrees, and both sides contain a set of tables which give the rafter and hip lengths in metres run for various rises in degrees.

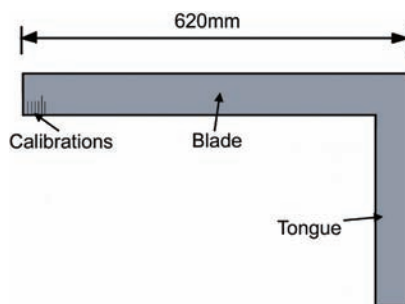

Steel roof square

To use the square, the rise of the roof is set on the tongue, and the run of the rafter is set on the blade.

Example. Consider a common rafter of a roof with a rise of 3m and a rafter run of 4.50m.

To accommodate the use of the square, the sizes are scaled down or reduced by.

Therefore:

$$\text{Rise } 3.00\text{m} \div 10 = 300\text{mm}$$

$$\text{Run } 4.50\text{m} \div 10 = 450\text{mm}$$

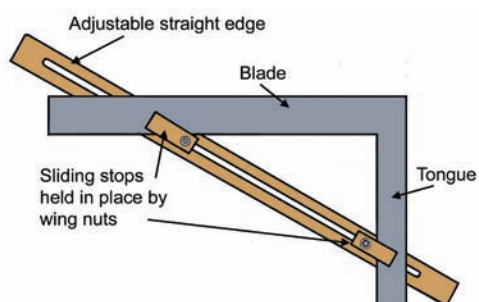

Steel roofing square with adjustable fence



Student Key Skill

Application of Number

Use of steel roofing square

Below is an example of how the square is applied. The lengths will be to scale and will need to be converted to full size.

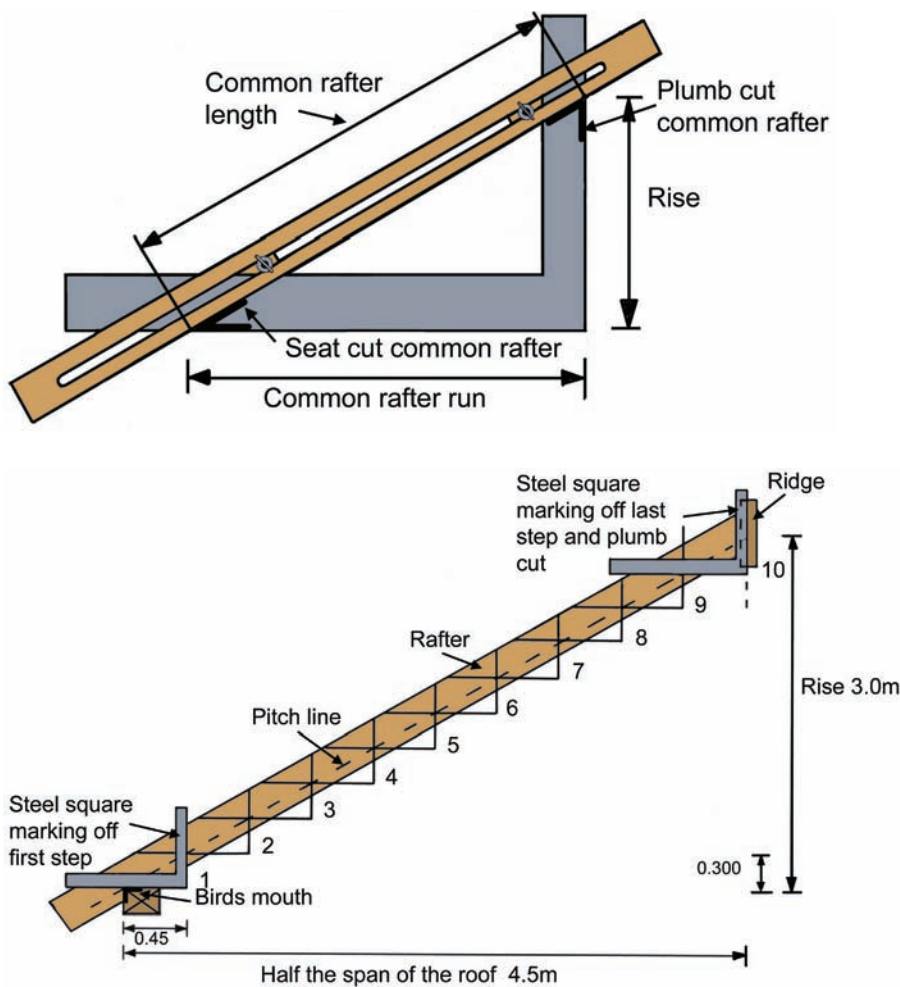

The drawing shows how the length and angles are set off for a common rafter. The same procedure can be used to obtain all the other rafter lengths and angles using the following combinations.

- Common rafter run + common rafter run = Hip run.
- Hip run + rise = Hip length and cuts.
- Hip length + rise = Hip backing bevel.
- Hip length + hip run = Hip edge cut.
- Common rafter length + common rafter run = Purlin edge cut.
- Common rafter length + rise = Purlin side cut.